

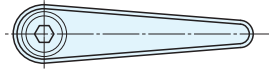

把手			入子
材質	處理	顏色	材質
鋅合金	塗裝	橘、黑	SUS303

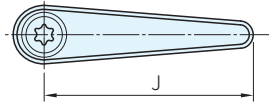

內六角孔



星型孔

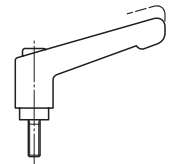
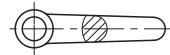
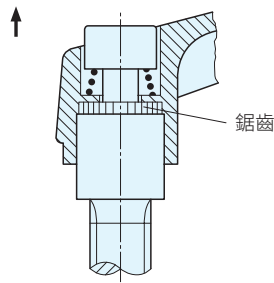
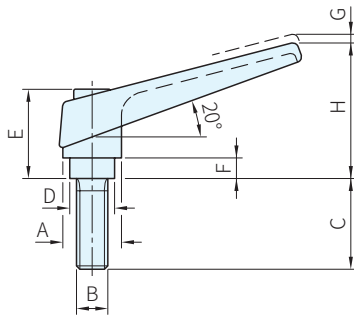

SIZE M4

橘色 品號	黑色 品號	A	B	C	D	E	F	G	H	J	質量 g	庫存
24390.0010	24390.0012	13	M4	12				3.5	30.5	30	27	•
24390.0014	24390.0016			16							•	
24390.0018	24390.0020			20							•	
24390.0022	24390.0024			25							•	
24390.0026	24390.0028			32							•	
24390.0041	24390.0044	14	M5	12	10.0	24.5	4.0		35.0	45	36	•
24390.0051	24390.0054			16							•	
24390.0061	24390.0064			20							•	
24390.0071	24390.0074			25							•	
24390.0081	24390.0084			32							•	
24390.0086	24390.0089	40	•									
24390.0131	24390.0134	14	M6	12				3.0	35.0	45	37	•
24390.0141	24390.0144			16							•	
24390.0151	24390.0154			20							•	
24390.0161	24390.0164			25							•	
24390.0171	24390.0174			32							•	
24390.0181	24390.0184	40	•									
24390.0191	24390.0194	50	•									
24390.0331	24390.0334	18	M8	16	13.5	31.0	6.5		45.0	62	74	•
24390.0341	24390.0344			20							•	
24390.0351	24390.0354			25							•	
24390.0361	24390.0364			32							•	
24390.0371	24390.0374			40							•	
24390.0381	24390.0384			50							•	
24390.0391	24390.0394			63							•	

橘色 品號	黑色 品號	A	B	C	D	E	F	G	H	J	質量 g	庫存
24390.0441	24390.0444	22	M10	20	16.0	36.0	8.0	3.5	52.0	74	128	•
24390.0451	24390.0454			25							130	•
24390.0461	24390.0464			32							134	•
24390.0471	24390.0474			40							138	•
24390.0481	24390.0484			50							143	•
24390.0486	24390.0489			63							148	•
24390.0491	24390.0494			80							157	•
24390.0541	24390.0544			25							M12	25
24390.0551	24390.0554	32	209		•							
24390.0561	24390.0564	40	215		•							
24390.0571	24390.0574	50	222		•							
24390.0581	24390.0584	63	232		•							
24390.0591	24390.0594	80	240		•							
24390.0641	24390.0644	30	M16	32	23.0	50.5	12.0	5.0	76.0	108	348	•
24390.0651	24390.0654			40							357	•
24390.0661	24390.0664			50							370	•
24390.0671	24390.0674			63							386	•
24390.0681	24390.0684			80							407	•

WA. 注意

- 把手內六角孔售完將改以星型孔出貨

 訂貨： 交期：

24390.0010

SP. 特長

- 把手入子為不銹鋼，適合多種應用，如醫療環境、化學工廠等
- 把手位置上拉後可自由調整，放鬆後齒合復位

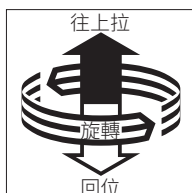
**EX. 使用例**